

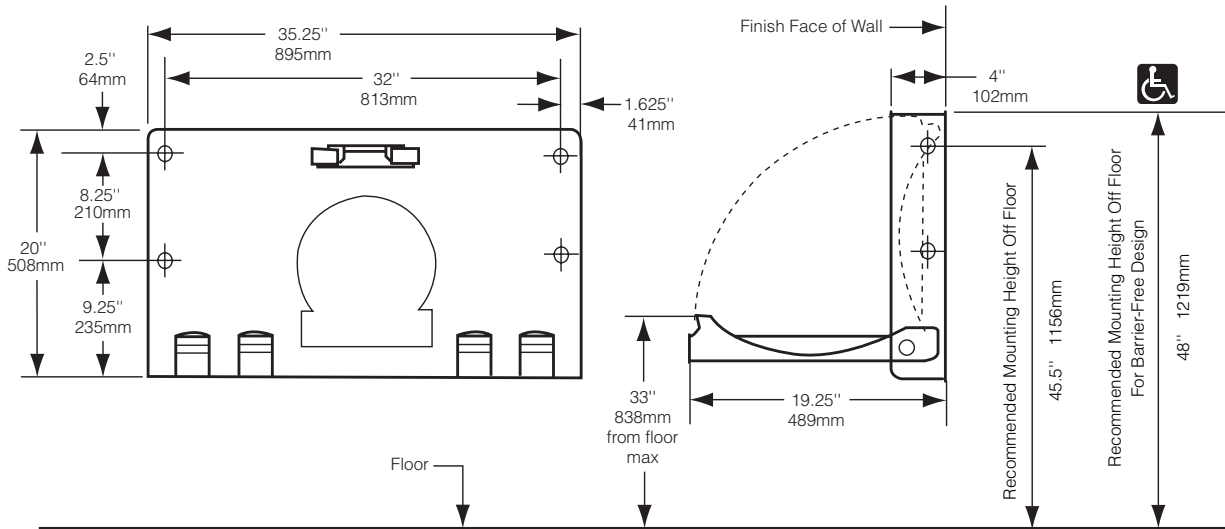

Koala Kare Products
A Division of Bobrick

HORIZONTAL WALL-MOUNTED BABY CHANGING STATION

KB100-00 CREAM



ADA Compliance

- (when properly installed)
- 4.4.1 Max. Protruding Objects
 - 4.2.5 Forward Reach
 - 4.2.6 Side Reach
 - 4.27.4 Operation

MATERIALS:

FDA approved blow-molded high-density polyethylene with Microban Antimicrobial additive. Reinforced full-length steel-on-steel hinge mechanism, with 11-gauge steel mounting plates and mounting hardware included. Molded in graphics and safety messages in six languages and Braille. Contoured changing surface area is 442 sq in (2873 sq mm) and comes complete with nylon safety straps and bag hooks.

continued . . .

OPERATION:

Concealed pneumatic cylinder and hinge structure provides controlled, slow opening and closing of bed. High-density polyethylene is easy to clean and resists odors and bacterial growth. Complies with ASTM static load performance requirements when properly installed. Molded-in liner dispenser holds approximately 25 KB150-99 sanitary liners.

Warning: *To insure that the unit supports the intended loads, baby changing stations must be properly installed according to the manufacturer's instructions.*

INSTALLATION:

To insure proper installation and compliance to building codes, it is recommended that a qualified person or carpenter perform the installation of the unit. The unit must be properly installed onto a permanent wall that is capable of supporting significant weight and can accommodate the supplied installation hardware. The Koala Bear Kare® Baby Changing Station meets ADA regulations when properly installed.

Drilling holes and mounting the station:

1. Remove the station from the shipping container and check for any freight damage. Identify the best location for installing the baby changing station. Hold the unit in place, open the bed, and make sure that there is adequate operating clearance.
2. Based upon the type of wall on which the unit will be mounted, determine the best method of mounting. Not all of included hardware may be required for proper installation.
3. The horizontal unit has four mounting holes provided in the back wall of the unit, which are positioned on a 32" stud center. If possible, locate the wood or metal wall studs for fastening the changing station in the desired location. If the walls do not have studs on the center as outlined, make sure at least one side of the unit is installed into the stud. Use toggles (supplied) for holes on the other side.
4. Find the stud where you will be attaching the left side of the changing station to the wall. Measure 45.5" (1156mm) up from the floor, at the center of the stud, and mark the wall. Line up the top left mounting hole with this mark, then use a measuring tape and level to mark the remaining three mounting holes. This will locate the bottom of the station 28" (711mm) from the floor and the top of the bed at 33" (838mm).

Using Wood Screws:

If the wall has wood studs on 16" or 32" centers, drill 1/8" pilot holes at the marks and use the four 1/4" x 3" panhead tapping screws with supplied washers. If the wall is masonry or tile over wood studs, use a 7/32" masonry drill until you hit the stud, then proceed to drill 1/8" pilot holes into the studs and use the four 1/4" x 3" panhead tapping screws with supplied washers.

Using Toggle Fasteners:

If the wall has wood studs that are not on 16" or 32" centers, has metal studs, or an underlying surface of concrete block, drill with a 1/2" masonry bit. A minimum of 2-1/2" of inside wall space is required for toggles to turn. Insert supplied toggles and tighten, locate station over toggles, then use supplied 1/4" x 3" Phillips Panhead machine screws with supplied washers.

SPECIFICATION:

Baby changing station body shall be durable, high-density polyethylene. Design of unit shall be surface-mounted. Unit shall be equipped with a pneumatic cylinder for controlled opening and closing of bed. Bed shall be secured to back plate with a concealed, full-length steel-on-steel hinge. No hinge structure shall be exposed on interior or exterior surfaces. Unit shall have 11-gauge steel mounting plates with mounting hardware included. Unit shall have Microban Antimicrobial embedded into plastic material. Unit shall conform to ANSI S117.1 Accessible and Usable Buildings and Facilities, ASTM F2285-04 (formerly ASTM PS125) Standard Safety Performance Specification for Diaper Changing Tables for Commercial Use, ANSI Z535.4 Product Safety Signs and Labels, German TUV Technical Inspection Association, ASTM G21 Antifungal and ASTM G22 Antibacterial Standards or local code if more stringent installation requirements are applicable for barrier-free accessibility. Unit shall comply with ADA regulations when properly installed. Bed shall have smooth concave changing area with a nylon safety strap and two hooks for bags or purses. Unit shall have a built-in Liner Dispenser for use with 3-ply chemical-free biodegradable sanitary liners, universal instruction graphics, and safety messages in 6 languages and Braille. Unit shall be backed by manufacturer's 5-year limited warranty on materials and workmanship, and a 5-year replacement warranty against vandalism. Unit shall be manufactured in the U.S.A.

Baby Changing Station shall be model KB100-00 of Koala Kare Products, A Division of Bobrick, 8962 S. Quentin St., Centennial, CO 80112 USA, Tel: 1-888-733-3456 or 303-539-8359, Web: www.koalabear.com